

### Product Overview

The QPD1003 is a 500 W ( $P_{3dB}$ ) internally matched discrete GaN on SiC HEMT which operates from 1.2 to 1.4 GHz and a 50V supply rail. The device is GaN IMFET fully matched to 50  $\Omega$  in an industry standard air cavity package and is ideally suited for military and civilian radar. The device can support pulsed and linear operations.

ROHS compliant.

Evaluation boards are available upon request.



### Functional Block Diagram

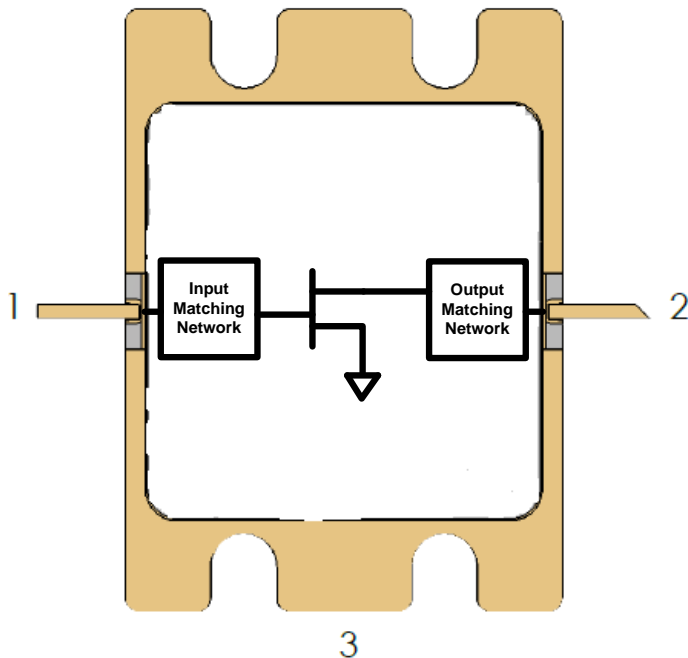

### Key Features

- Frequency: 1.2 to 1.4 GHz
  - Output Power ( $P_{3dB}$ )<sup>1</sup>: 540 W
  - Linear Gain<sup>1</sup>: 19.9 dB
  - Typical PAE<sub>3dB</sub><sup>1</sup>: 66.7%
  - Operating Voltage: 50 V
  - Low thermal resistance package
  - Pulse capable
- Note 1: @ 1.3 GHz

### Applications

- Military radar
- Civilian radar

Part No.	Description
QPD1003	1.2–1.4 GHz RF IMFET
QPD1003PCB401	1.2–1.4 GHz EVB



# QPD1003

## 500W, 50V, 1.2 – 1.4 GHz, GaN RF IMFET

### Absolute Maximum Ratings<sup>1</sup>

Parameter	Rating	Units
Breakdown Voltage, $BV_{DG}$	+145	V
Gate Voltage Range, $V_G$	-7 to +2	V
Drain Current, $I_{D_{MAX}}$	20	A
Gate Current Range, $I_G$	See page 4.	mA
Power Dissipation, 10% DC 1 mS PW, $P_{DISS}$	410	W
RF Input Power, 10% DC 1 mS PW, 1.3 GHz, $T = 25\text{ }^\circ\text{C}$	+42	dBm
Mounting Temperature (30 Seconds)	320	$^\circ\text{C}$
Storage Temperature	-65 to +150	$^\circ\text{C}$

Notes:

1. Operation of this device outside the parameter ranges given above may cause permanent damage.

### Recommended Operating Conditions<sup>1</sup>

Parameter	Min	Typ	Max	Units
Operating Temp. Range	-40	+25	+85	$^\circ\text{C}$
Drain Voltage Range, $V_D$	+28	+50	+55	V
Drain Bias Current, $I_{DQ}$	-	750	-	mA
Drain Current, $I_D$	-	15	-	A
Gate Voltage, $V_G$ <sup>4</sup>	-	-2.8	-	V
Power Dissipation, Pulsed ( $P_D$ ) <sup>2, 3</sup>	-	-	370	W

Notes:

1. Electrical performance is measured under conditions noted in the electrical specifications table. Specifications are not guaranteed over all recommended operating conditions.
2. Package base at 85  $^\circ\text{C}$
3. Pulse Width = 1 mS, Duty Cycle = 10%
4. To be adjusted to desired  $I_{DQ}$

### Pulsed Characterization – Load-Pull Performance – Power Tuned<sup>1</sup>

Parameters	Typical Values			Unit
Frequency, F	1.2	1.3	1.4	GHz
Linear Gain, $G_{LIN}$	19	19.9	18.6	dB
Output Power at 3dB compression point, $P_{3dB}$	57.3	57.3	57	dBm
Power-Added-Efficiency at 3dB compression point, $PAE_{3dB}$	55.1	57.6	56.9	%
Gain at 3dB compression point	16	16.9	15.6	dB

Notes:

1. Test conditions unless otherwise noted:  $V_D = +50\text{ V}$ ,  $I_{DQ} = 750\text{ mA}$ ,  $Temp = +25\text{ }^\circ\text{C}$

### Pulsed Characterization – Load-Pull Performance – Efficiency Tuned<sup>1</sup>

Parameters	Typical Values			Unit
Frequency, F	1.2	1.3	1.4	GHz
Linear Gain, $G_{LIN}$	20.3	20.6	19.4	dB
Output Power at 3dB compression point, $P_{3dB}$	55.4	55.6	55.3	dBm
Power-Added-Efficiency at 3dB compression point, $PAE_{3dB}$	70.3	66.7	67.4	%
Gain at 3dB compression point, $G_{3dB}$	17.3	17.6	16.4	dB

Notes:

1. Test conditions unless otherwise noted:  $V_D = +50\text{ V}$ ,  $I_{DQ} = 750\text{ mA}$ ,  $Temp = +25\text{ }^\circ\text{C}$

### RF Characterization – 1.2 – 1.4 GHz EVB Performance At 1.2 GHz<sup>1</sup>

Parameter	Min	Typ	Max	Units
Linear Gain, $G_{LIN}$	–	18.6	–	dB
Output Power at 3dB compression point, $P_{3dB}$	–	57.1	–	dBm
Power-Added Efficiency at 3dB compression point, $PAE_{3dB}$	–	57.7	–	%
Gain at 3dB compression point, $G_{3dB}$	–	15.6	–	dB

Notes:

1.  $V_D = +50$  V,  $I_{DQ} = 750$  mA, Temp = +25 °C, CW

### RF Characterization – 1.2 – 1.4 GHz EVB Performance At 1.3 GHz<sup>1</sup>

Parameter	Min	Typ	Max	Units
Linear Gain, $G_{LIN}$	–	19.8	–	dB
Output Power at 3dB compression point, $P_{3dB}$	–	56.6	–	dBm
Power-Added Efficiency at 3dB compression point, $PAE_{3dB}$	–	62.0	–	%
Gain at 3dB compression point, $G_{3dB}$	–	16.8	–	dB

Notes:

1.  $V_D = +50$  V,  $I_{DQ} = 750$  mA, Temp = +25 °C, CW

### RF Characterization – 1.2 – 1.4 GHz EVB Performance At 1.4 GHz<sup>1</sup>

Parameter	Min	Typ	Max	Units
Linear Gain, $G_{LIN}$	–	18.5	–	dB
Output Power at 3dB compression point, $P_{3dB}$	–	56.4	–	dBm
Power-Added Efficiency at 3dB compression point, $PAE_{3dB}$	–	59.2	–	%
Gain at 3dB compression point, $G_{3dB}$	–	15.5	–	dB

Notes:

1.  $V_D = +50$  V,  $I_{DQ} = 750$  mA, Temp = +25 °C, CW

### RF Characterization – Mismatch Ruggedness at 1.3 GHz<sup>1</sup>

Symbol	Parameter	dB Compression	Typical
VSWR	Impedance Mismatch Ruggedness	3	5:1

Notes:

1. Test conditions unless otherwise noted:  $T_A = 25$  °C,  $V_D = 50$  V,  $I_{DQ} = 750$  mA, 1 mS PW, 10% DC
2. Driving input power is determined at pulsed compression under matched condition at EVB output connector.

Maximum Gate Current

Maximum Gate Current Vs. IR Surface Temperature

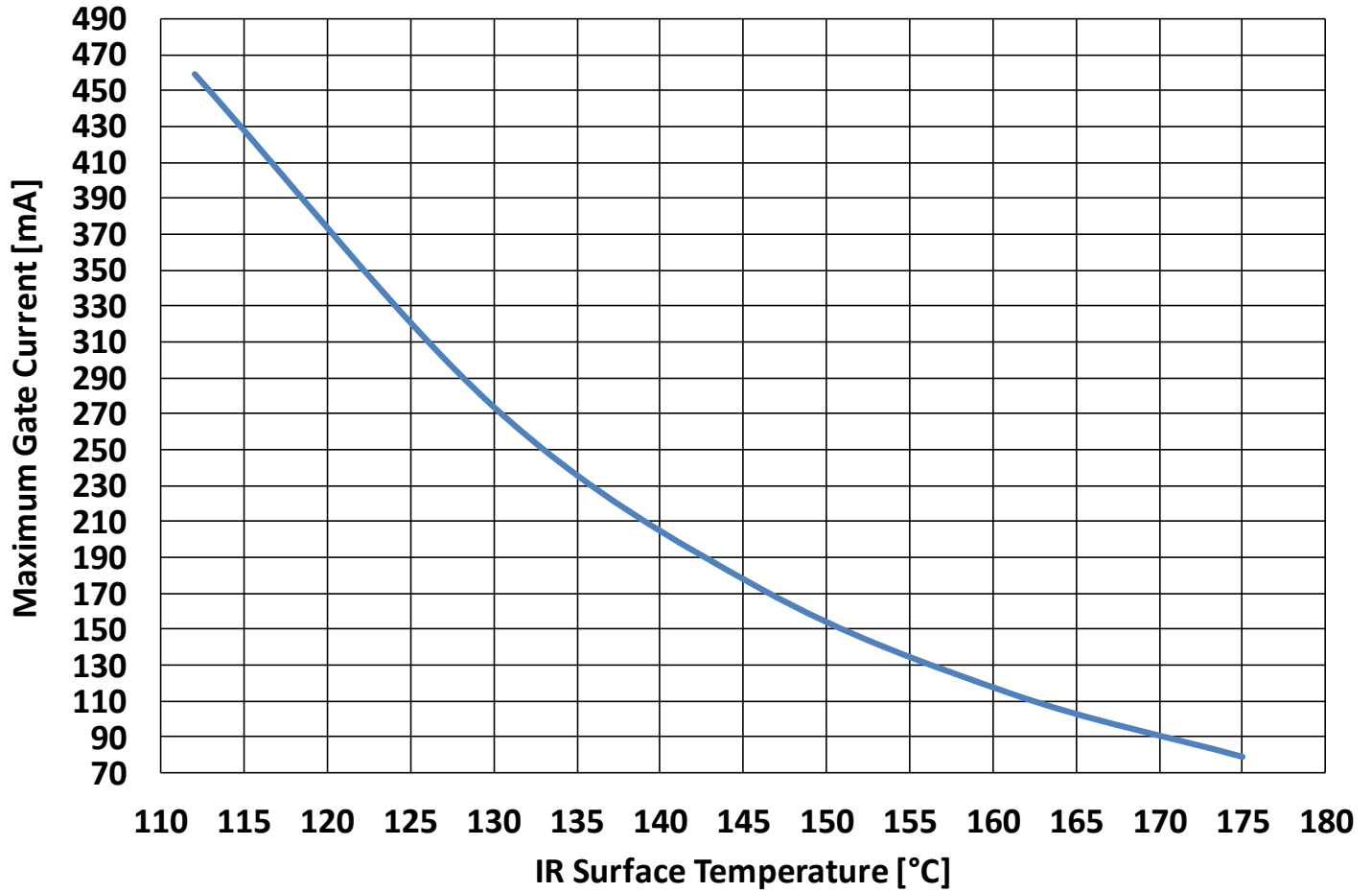

Thermal and Reliability Information – Pulsed

Peak IR Surface Temperature vs. Pulse Width

Pdiss = 346 W, Base Temperature @ 85 °C

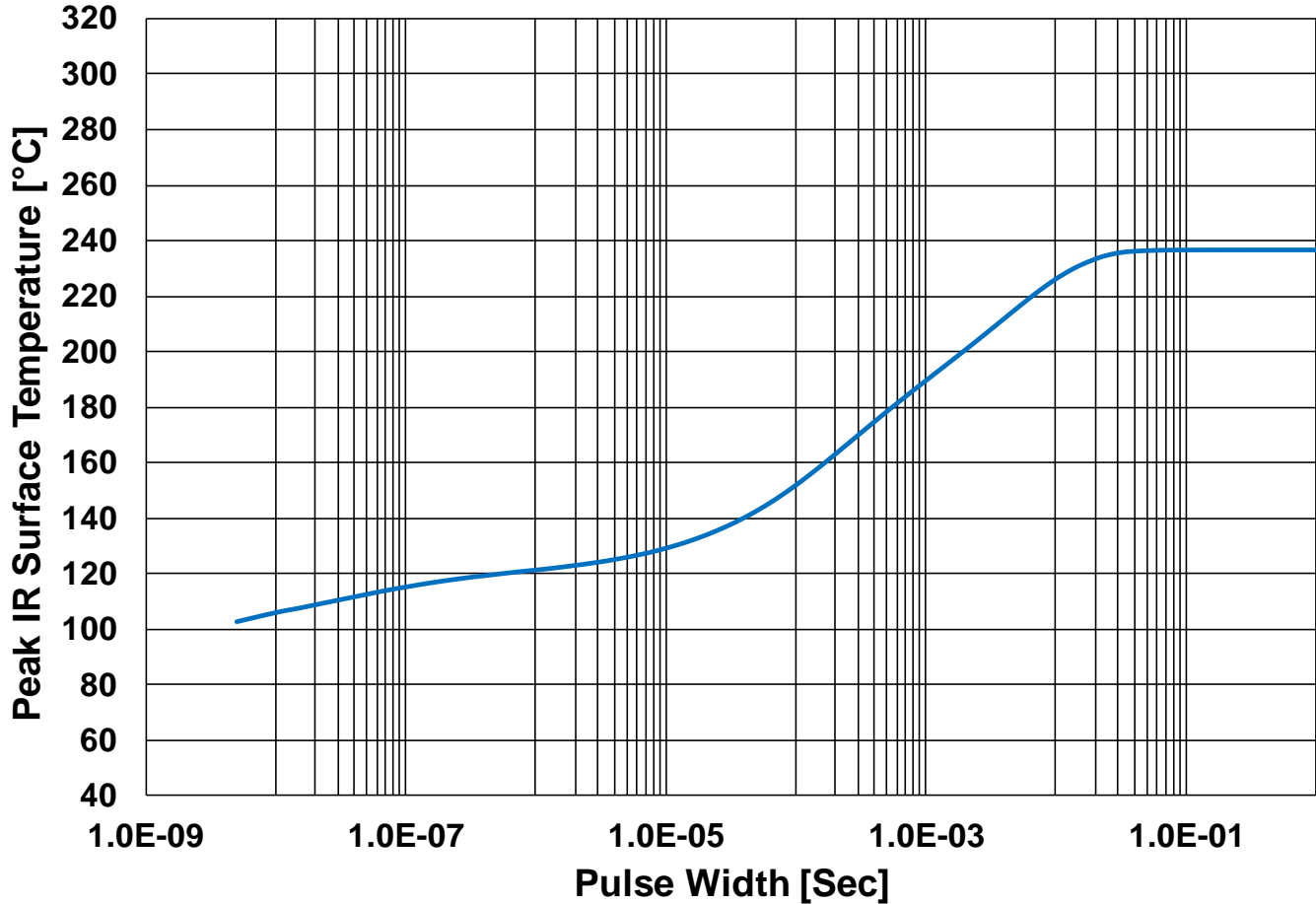

Parameter	Conditions	Values	Units
Thermal Resistance, IR <sup>1</sup> ( $\theta_{JC}$ )	85 °C back side temperature	0.30	°C/W
Peak IR Surface Temperature <sup>1</sup> ( $T_{CH}$ )	346 W Pdiss, 1 mS PW, 10% DC	189	°C

<sup>1</sup>Refer to the following document [GaN Device Channel Temperature, Thermal Resistance, and Reliability Estimates](#)

Load-Pull Smith Charts<sup>1, 2, 3</sup>

Notes:

1.  $V_D = 50\text{ V}$ ,  $I_{DQ} = 750\text{ mA}$ , 1 ms PW, 10% DC pulsed. Performance is at 3dB gain compression referenced to peak gain.
2. See page 13 for load-pull and source-pull reference planes. 50-Ω load-pull TRL fixtures are built with 20-mil RO4350B material.
3. NaN means the impedances are either undefined or varying in load-pull system.

1.2GHz, Load-pull

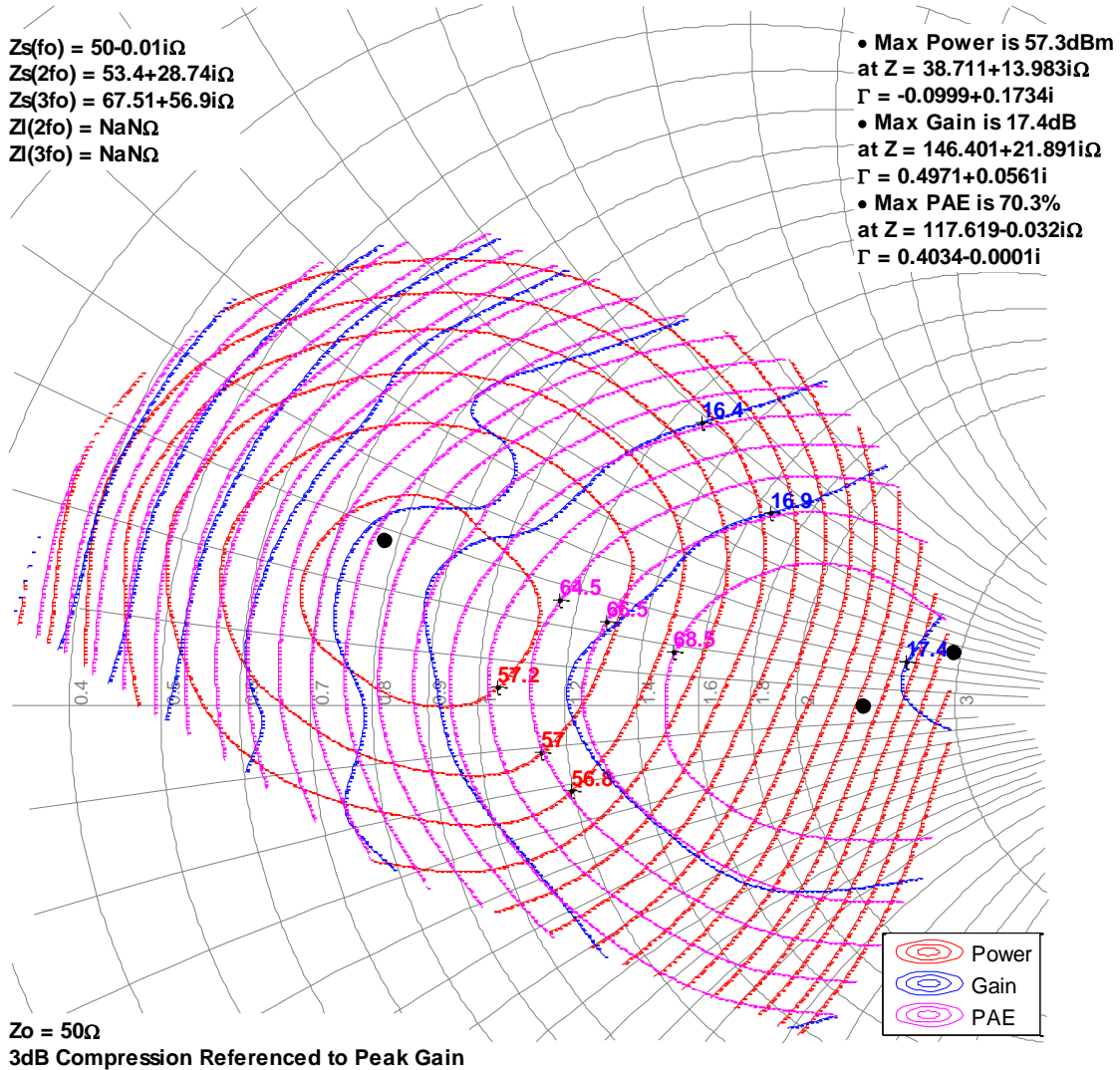

Load-Pull Smith Charts<sup>1, 2, 3</sup>

Notes:

1.  $V_D = 50\text{ V}$ ,  $I_{DQ} = 750\text{ mA}$ , 1 ms PW, 10% DC pulsed. Performance is at 3dB gain compression referenced to peak gain.
2. See page 13 for load-pull and source-pull reference planes. 50-Ω load-pull TRL fixtures are built with 20-mil RO4350B material.
3. NaN means the impedances are either undefined or varying in load-pull system.

1.3GHz, Load-pull

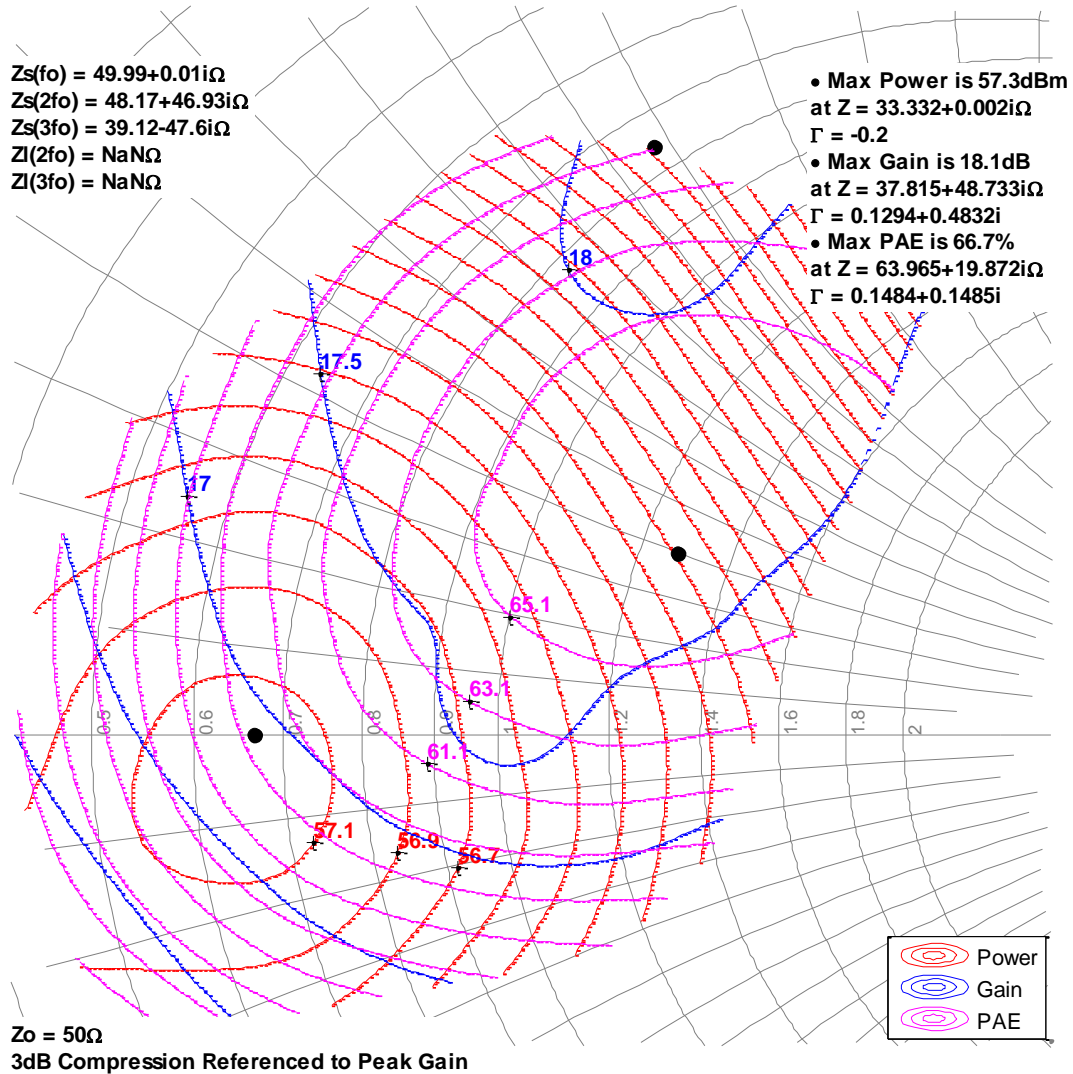

Load-Pull Smith Charts<sup>1, 2, 3</sup>

Notes:

1.  $V_D = 50\text{ V}$ ,  $I_{DQ} = 750\text{ mA}$ , 1 ms PW, 10% DC pulsed. Performance is at 3dB gain compression referenced to peak gain.
2. See page 13 for load-pull and source-pull reference planes. 50- $\Omega$  load-pull TRL fixtures are built with 20-mil RO4350B material.
3. NaN means the impedances are either undefined or varying in load-pull system.

1.4GHz, Load-pull

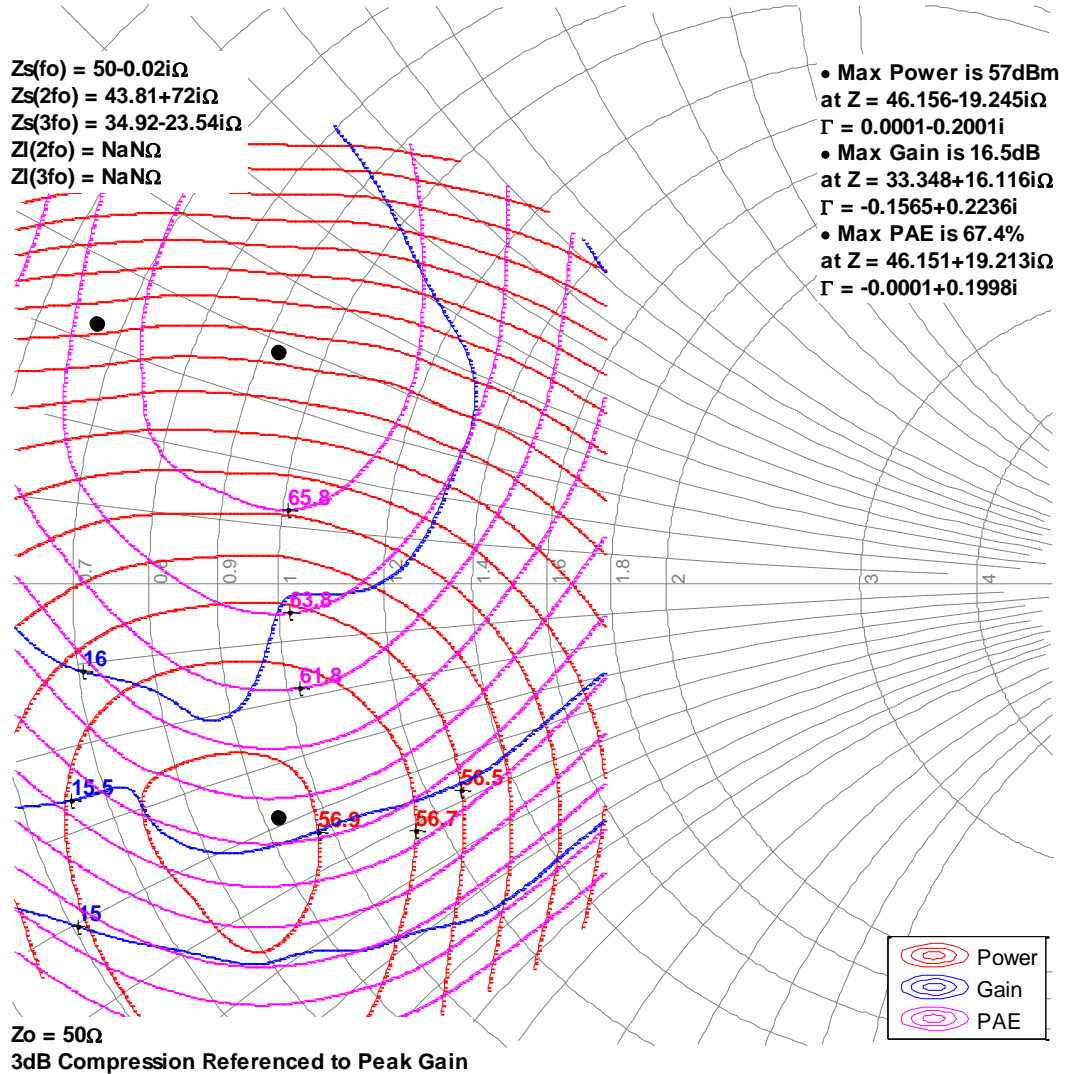



### Typical Performance – Load-Pull Drive-up<sup>1, 2</sup>

Notes:

1. 1 mS PW, 10% DC pulsed signal,  $V_D = 50\text{ V}$ ,  $I_{DQ} = 750\text{ mA}$
2. See page 13 for load-pull and source-pull reference planes where the performance was measured.

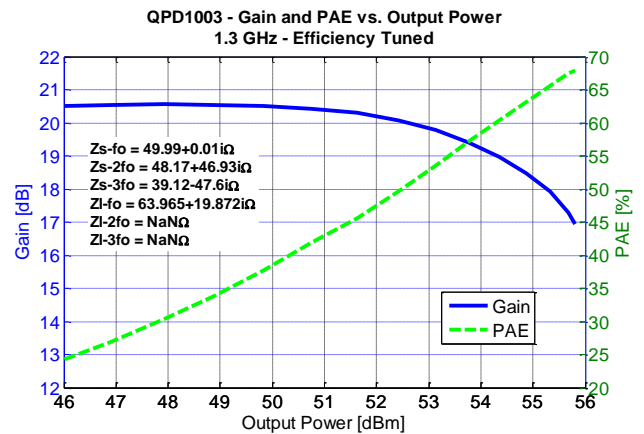
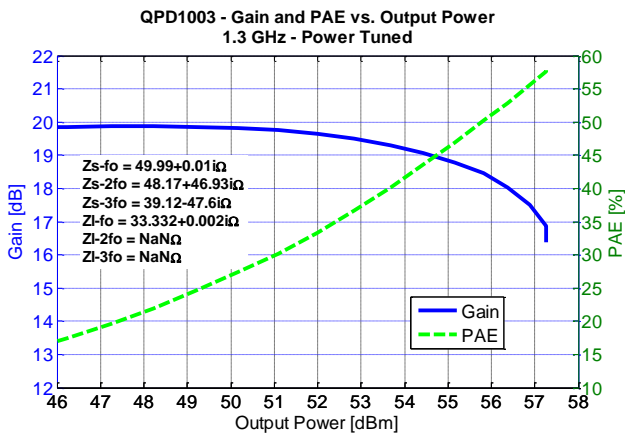
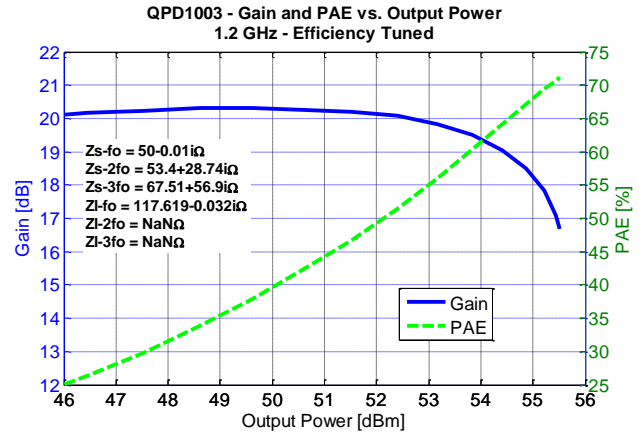
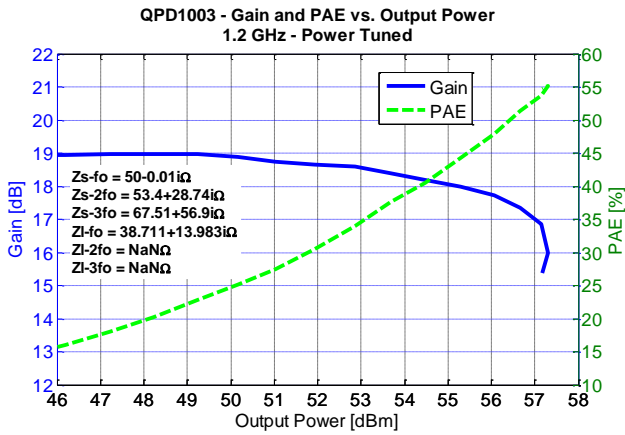

### Typical Performance – Load-Pull Drive-up<sup>1, 2</sup>

Notes:

1. 1 mS PW, 10% DC pulsed signal,  $V_D = 50\text{ V}$ ,  $I_{DQ} = 750\text{ mA}$
2. See page 13 for load-pull and source-pull reference planes where the performance was measured.

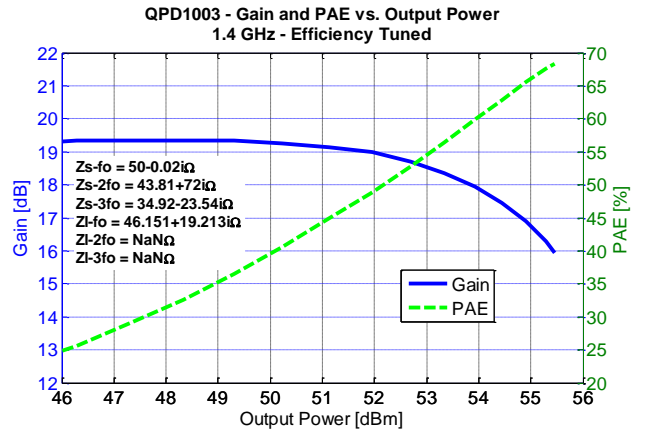
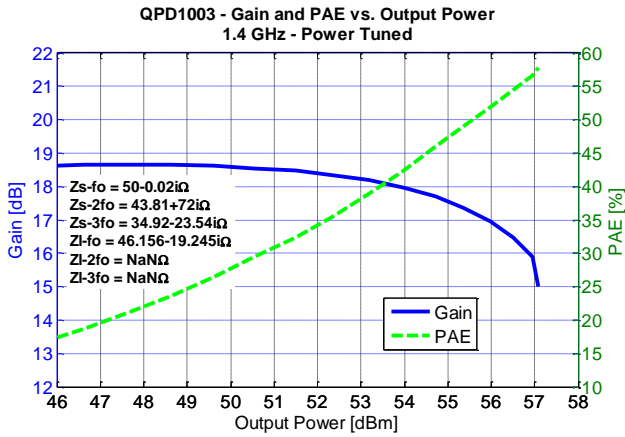

### Power Drive-up Performance Over Temperatures Of 1.2 – 1.4 GHz EVB<sup>1</sup>

Notes:

- $V_D = 50\text{ V}$ ,  $I_{DQ} = 750\text{ mA}$ ,  $1\text{ mS PW}$ ,  $10\% \text{ DC}$

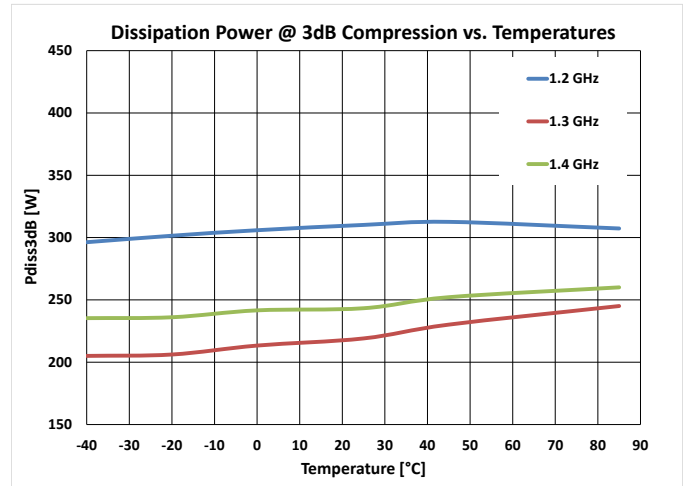
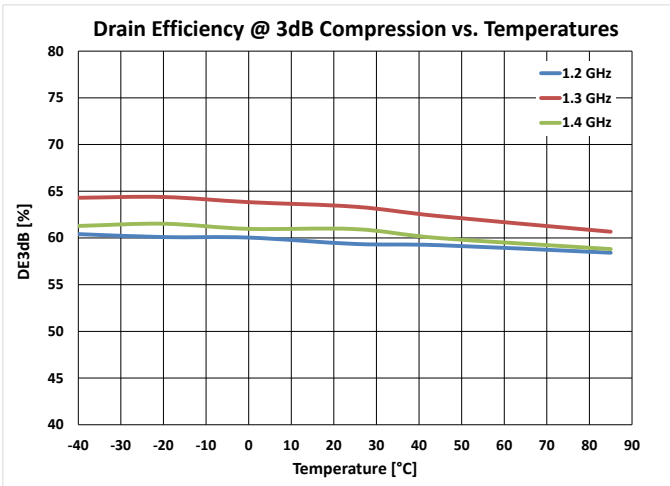
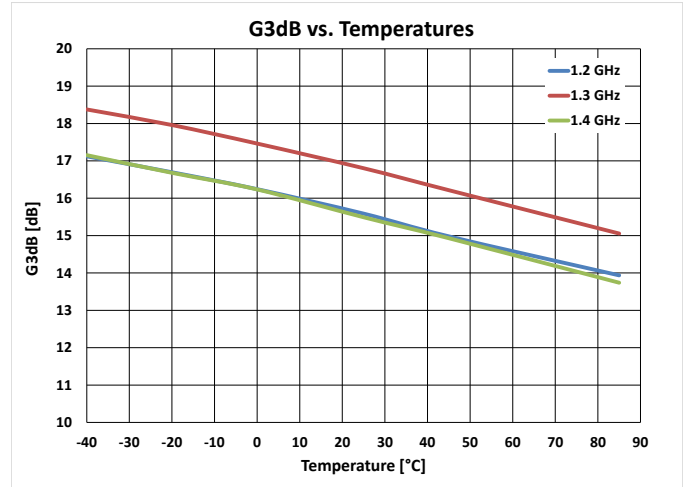
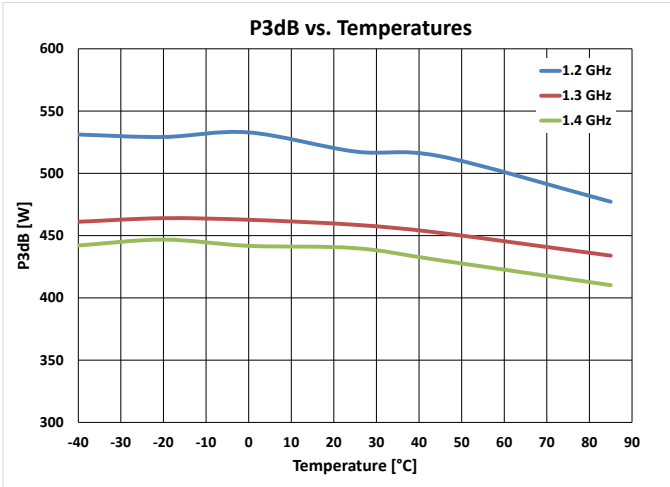

### Power Drive-up Performance At 25 °C Of 1.2 – 1.4 GHz EVB<sup>1</sup>

Notes:

- $V_D = 50\text{ V}$ ,  $I_{DQ} = 750\text{ mA}$ , 1 mS PW, 10% DC

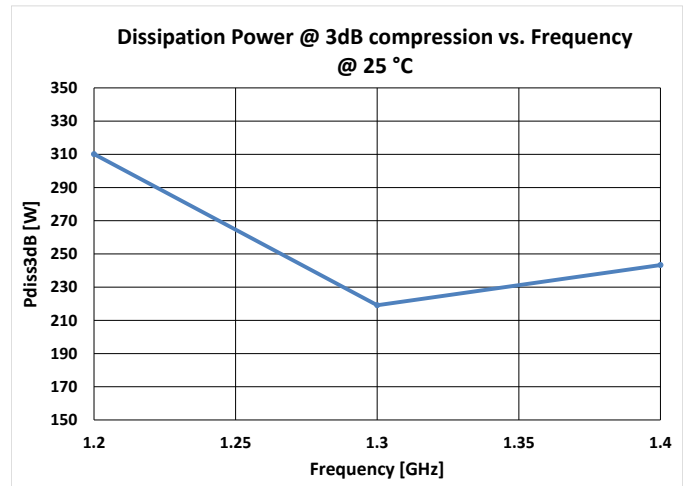
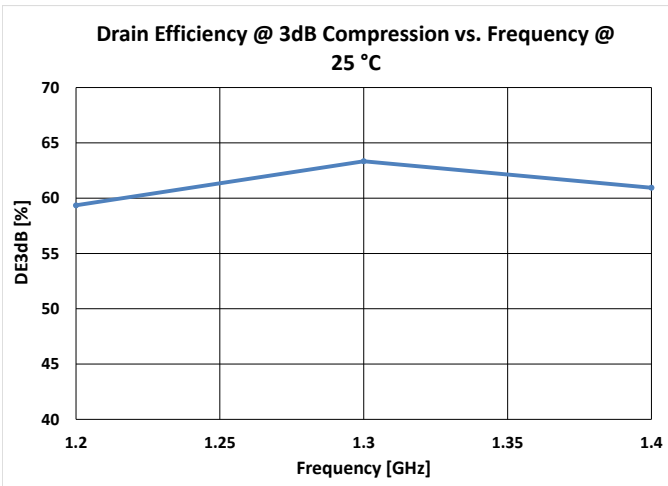
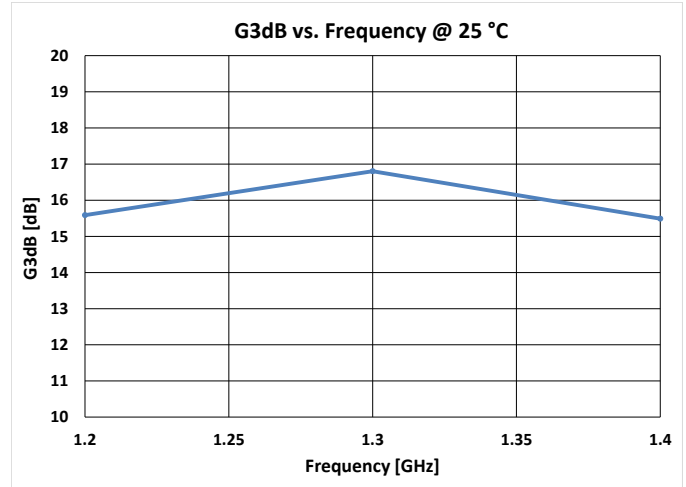
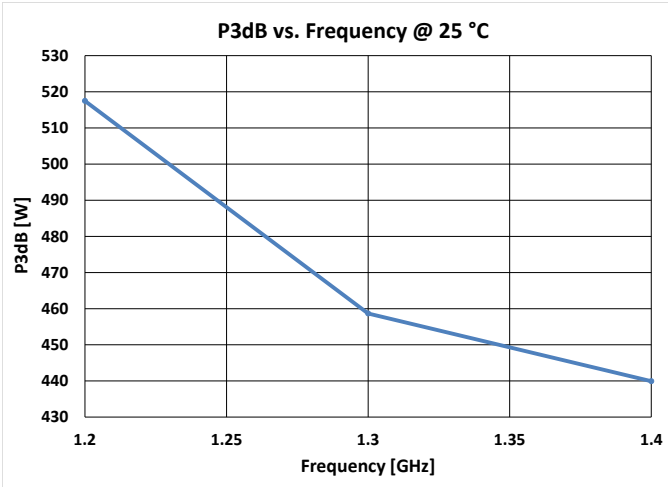

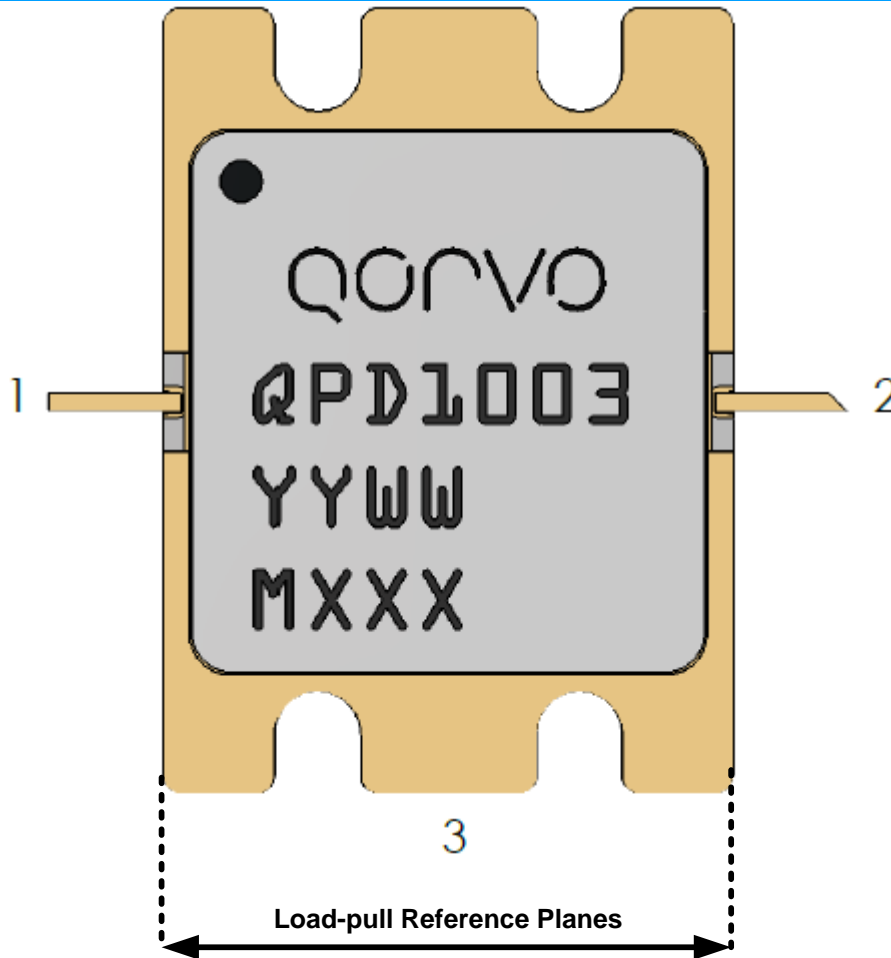
**Pin Configuration and Description, and Package Marking<sup>1</sup>**

**Pin Description**

Pin	Symbol	Description
1	$V_G$ / RF IN	Gate voltage / RF Input
2	$V_D$ / RF OUT	Drain voltage / RF Output
3	GND	Package base / Ground

**Notes:**

- The QPD1003 will be marked with the “1003” designator and a lot code marked below the part designator. The “YY” represents the last two digits of the calendar year the part was manufactured, the “WW” is the work week of the assembly lot start, the “MXXX” is the production lot number.

Package Dimensions<sup>1, 2, 3</sup>

NOTES: UNLESS OTHERWISE SPECIFIED;

1. PACKAGE IS AN ALL METAL DESIGN WITH CERAMIC LID AND FEED THRU'S.
2. PACKAGE IS Ni/Au PLATED.
3. PACKAGE IS EPOXY SEALED.
4. ALL DIMENSIONS ARE IN MM.

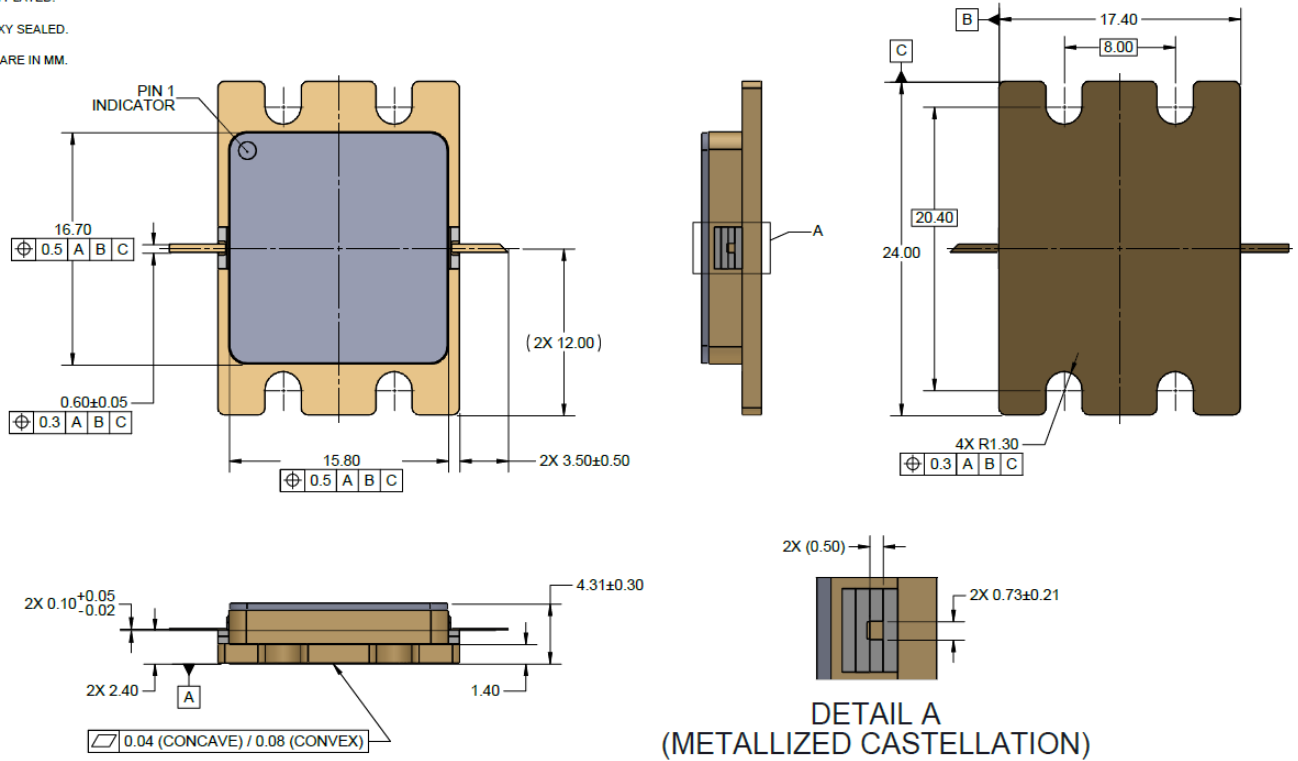

Notes:

1. Unless otherwise noted, the tolerance is ±0.15 mm.
2. For instruction to mount the part, please refer to application note "RF565 Package Mounting, Mechanical Mounting and PCB Considerations."

### Schematic – 1.2 – 1.4 GHz EVB

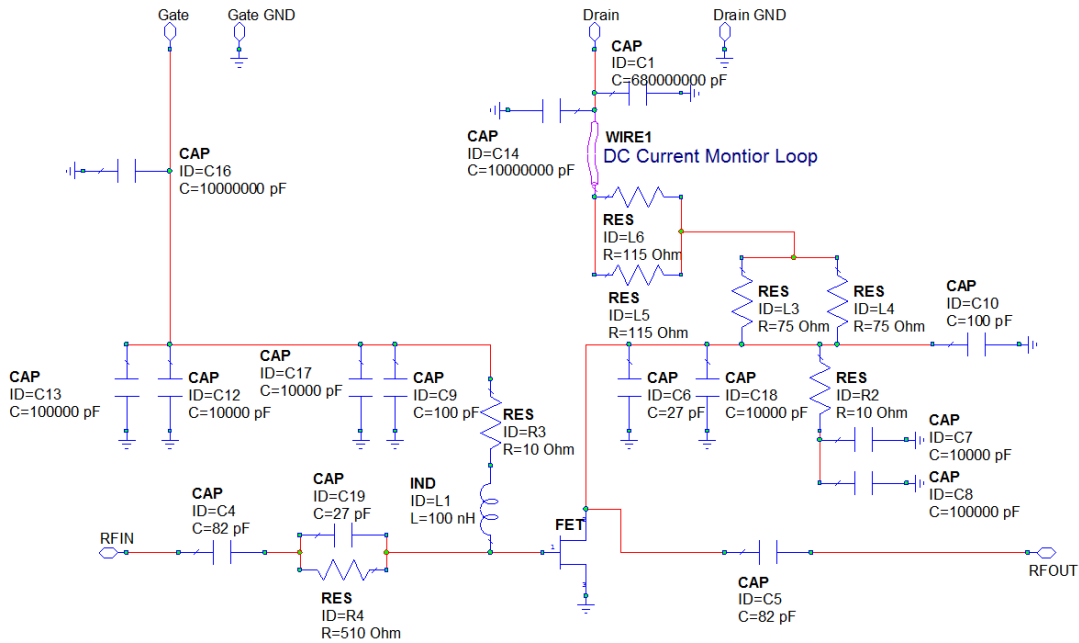

Bias-up Procedure	Bias-down Procedure
1. Set $V_G$ to -4 V.	1. Turn off RF signal.
2. Set $I_D$ current limit to 800 mA.	2. Turn off $V_D$
3. Apply 50 V $V_D$ .	3. Wait 2 seconds to allow drain capacitor to discharge
4. Slowly adjust $V_G$ until $I_D$ is set to 750 mA.	4. Turn off $V_G$
5. Set $I_D$ current limit to 2 A	
6. Apply RF.	

### 1.2 – 1.4 GHz EVB<sup>1</sup>

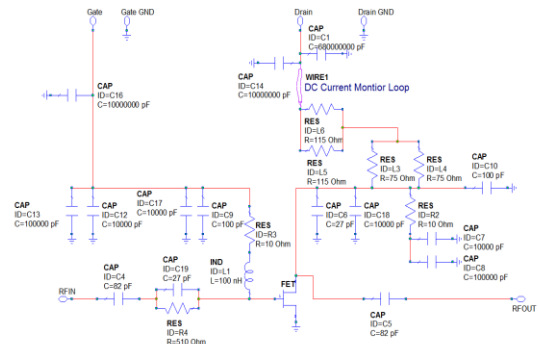
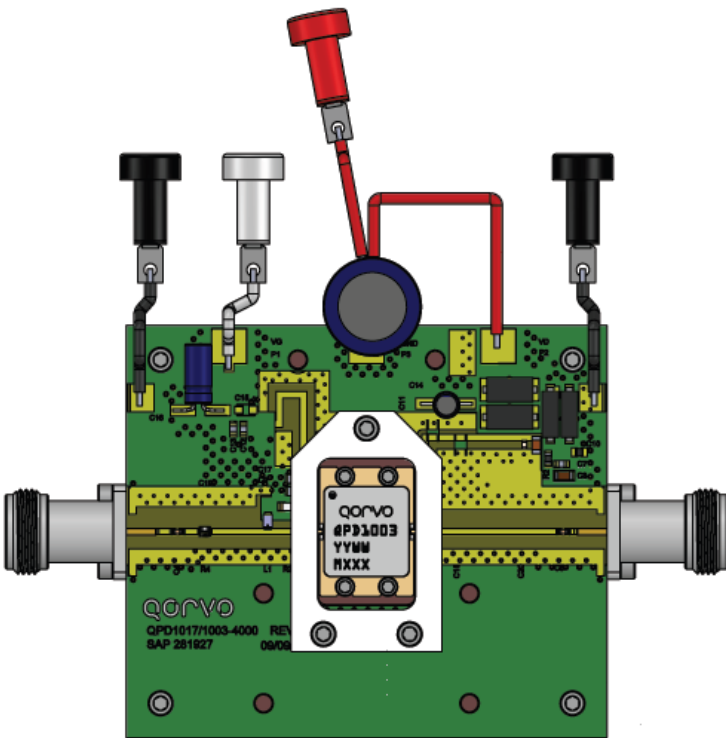

**Notes:**

1. PCB Material: RO4350B, 20 mil thickness, 1 oz copper cladding

### Bill Of material – 1.2 – 1.4 GHz EVB

Ref Des	Value	Qty	Manufacturer	Part Number
C1	680 uF	1	Panasonic	EEU-FC2A681
C4, C5	82 pF	2	ATC	ATC600S820JT250XT
C9	1000 pF	1	Samsung	CL31B102KGFNFNE
C6, C19	27 pF	2	ATC	600S270JT250XT
C7, C12	10000 pF	2	Panasonic	ECJ-2VB2A103K
C8	0.1 uF	1	Panasonic	ECJ-3YB2A104K
C10	100 pF	1	ATC	ATC800A101JT250X
C13	0.1 uF	1	Kemet	C0805C104K5RACTU
C14, C16	10 uF	2	Panasonic	ECA-2AM100
C17, C18	10000 pF	2	Samsung	CL31B103KGFNFNE
R2	51 OHM	1	Panasonic	ERJ-6GEYJ510
R3	10 OHM	1	Panasonic	ERJ-8GEYJ100V
R4	510 OHM	1	Panasonic	ERJ-6GEYJ511
L1	100 nH	1	Coilcraft	0603LS-101XJLB
L3, L4	n/a	1	STEWART, INC.	35F0121-1SR-10
L5, L6	n/a	1	STEWART, INC.	28F0181-1SR-10



Recommended Solder Temperature Profile

